

**CF Moto U10 XL Pro
Headache Rack**

SKU: TF281601

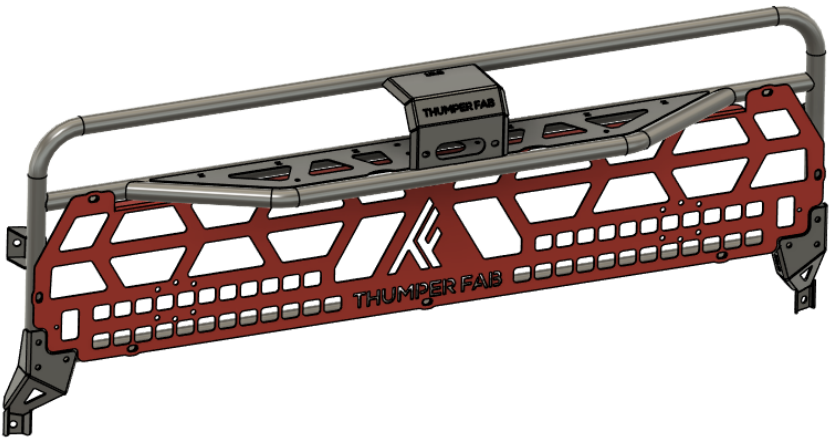

Thumper Fab
5103 Elysian Fields Rd, Marshall, TX 75672
Customer Service: 903-472-0928

CF Moto U10 XL Pro Headache Rack

SKU: TF281601



PARTS

REF	QTY	DESCRIPTION
1	1	Headache Rack Frame
2	1	Rear Panel
3	1	Lower Bracket - DR
4	1	Lower Bracket - PA
5	1	TF Big Game Winch
HARDWARE KIT		
A	4	M6x20mm Flange Head Bolt
B	4	M6 Split Lock Washer
C	7	M8x20mm Button Head Screw
D	4	M8x25mm Flange Head Bolt
E	6	M8x45mm Button Head Screw
F	6	M8 Nylon Lock Nuts
G	8	M8 Flat Washers
H	2	Truss Screws
I	1	Buck Connector

TOOLS

- 10mm Socket
- 13mm Socket and Wrench
- Snips
- Crimpers
- 5mm Allen Wrench

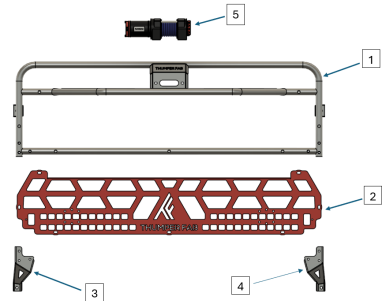
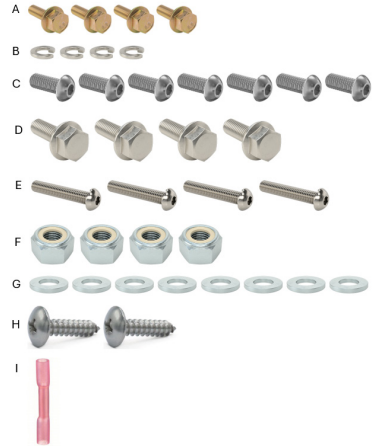

BEFORE YOU BEGIN

If you do not feel comfortable installing your **Thumper Fab** Headache Rack, please see your nearest Polaris® Dealer for

Torque Specs:

SIZE (STANDARD)	GRADE 5	GRADE 8	SIZE (METRIC)	CLASS 8.8	CLASS 10.9
5/16"	15 ft/lbs	20 ft/lbs	6MM	5 ft/lbs	9 ft/lbs
3/8"	30 ft/lbs	35 ft/lbs	8MM	18 ft/lbs	23 ft/lbs
7/16"	45 ft/lbs	60 ft/lbs	10MM	32 ft/lbs	45 ft/lbs
1/2"	65 ft/lbs	90 ft/lbs	12MM	55 ft/lbs	75 ft/lbs
9/16"	95 ft/lbs	130 ft/lbs	14MM	85 ft/lbs	120 ft/lbs
5/8"	135 ft/lbs	175 ft/lbs	16MM	130 ft/lbs	165 ft/lbs
3/4"	185 ft/lbs	280 ft/lbs	18MM	170 ft/lbs	240 ft/lbs

INSTALLATION INSTRUCTIONS

Installation Preparation

Fasten the rear panel to the headache rack frame using 7 x M8x20mm button head screws and 7 x M8 flat washers. Tighten using a 5mm allen wrench (**FIG 1**).



FIG 1 - Fasten Rear Panel to Headache Rack Frame

Fasten the fairlead to the headache rack frame using the hardware provided in the winch box (**FIG 2**).

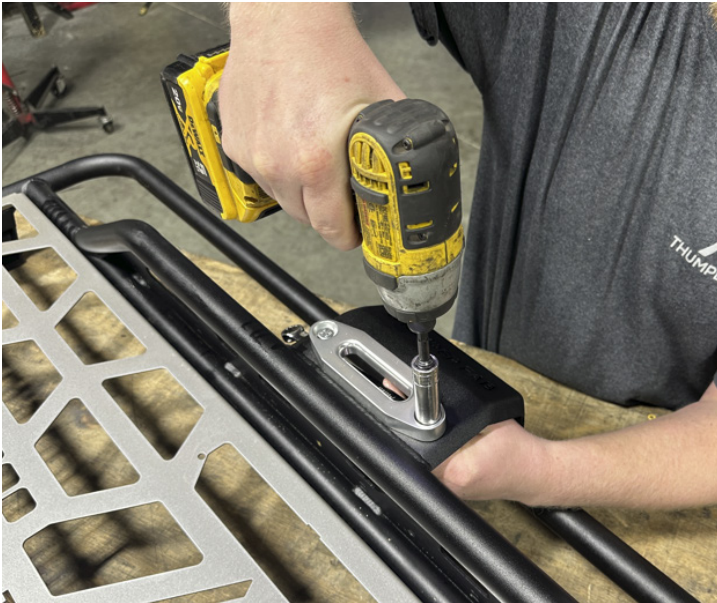

FIG 2 - Fasten Fairlead to Headache Rack Frame

INSTALLATION INSTRUCTIONS

Installation Preparation

Fasten the winch to the headache rack frame using 4 x M6x20mm flange head bolts and 4 x M6 split lock washers. Tighten using a 10mm socket (FIG 3).



FIG 3 - Fasten Winch to Headache Rack Frame

Fasten the winch stop to the winch cable using the hardware provided in the winch box (FIG 4).



FIG 4 - Fasten Winch Stop to Winch Cable

INSTALLATION INSTRUCTIONS

Installation Preparation

Mount the winch hook to the winch cable using a cotter pin (**FIG 5**).

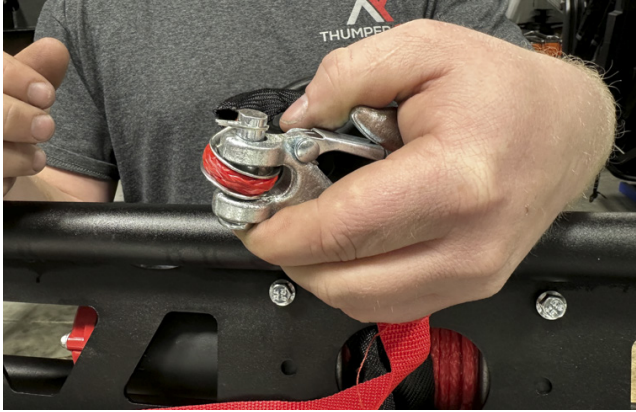

FIG 5 - Fasten the Winch Hook to the Winch Cable

Mount the headache switch to the rear panel of the headache rack using the hardware that is provided with the winch switch in the winch box (**FIG 6**).



FIG 6 - Mount the Winch Switch to the Rear Panel

INSTALLATION INSTRUCTIONS

If light option was selected, mount the light brackets to the cube lights using the hardware provided in the light box (**FIG 6**).



FIG 7 - Fasten Light Brackets to Cube Lights

Installation Preparation

Mount the cube light to the headache rack frame using the hardware provided in the cube light box. Zip tie light wire to frame using provided zip tie slots (**FIG 8**).



FIG 8 - Fasten the Cube Light to the Headache Rack Frame

INSTALLATION INSTRUCTIONS

Loosley mount lower brackets DR & PA to the frame using 2 X M8x25mm flange head bolts. Loosley tighten using a 13mm socket (**FIG 9**).



FIG 9 - Loosley Fasten Lower Brackets to Vehicle

Installation

Mount the headache rack to the vehicle starting with the upper mounts. Use 2 x M8x25mm flange head bolts to loosley fasten the frame to the vehicle (**FIG 10**).



FIG 10 - Fasten the Headache Rack to the Vehicle

INSTALLATION INSTRUCTIONS

Fasten the lower brackets to the headache rack frame using 6 x M8x45mm button head screws. Tighten using a 5mm allen wrench and a 13mm wrench (**FIG 11**).



FIG 11 - Fasten Lower Brackets to Headache Rack Frame

Installation

Fully tighten hardware that fastens lower brackets to headache rack frames. Tighten 4 x M8x25mm frame mounting bolts using a 13mm socket (**FIG 12**).



FIG 12 - Tighten Frame Mounting bolts using a 13mm Socket

INSTALLATION INSTRUCTIONS

Installation

Mount the winch contactor box under the rear middle seat using 2 x truss screws. Make sure all wiring is tied up away from hot or rotating components (**FIG 13**).



FIG 13 - Mount Contactor Box using Truss Screws

Winch Wiring

Do not refer to wiring instructions contained in the winch box as it is not suitable for this application. Reference the following wiring diagram for wiring instructions for the winch (**FIG 14**).

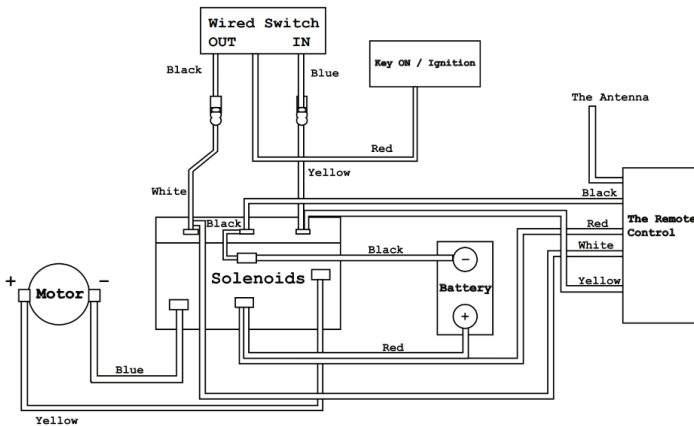

FIG 14 - Winch Wiring Diagram

INSTALLATION INSTRUCTIONS

Installation

If you have received a “new” style winch contactor box, there is no small red wire to connect to an ignition source. Simply wire the winch contactor box to the battery with the short red and black wires and connect the manual switch to the winch contactor box (**FIG 15**).



FIG 15 - Plug manual switch harness into winch contactor box

Winch Wiring

Once the winch harness is plugged into the winch contactor box, tighten the cable to the winch contactor box using your hands only. Pliers may strip the threads and should be avoided (**FIG 16**).



FIG 16 - Tighten switch harness to contactor box

INSTALLATION INSTRUCTIONS

Installation

Key on power can be located under middle seat from accessory pigtails to connect red wire from winch contactor box. Use crimpers to splice the red wire from winch contactor box and orange and red stripped wire from vehicle harness (key on power) together using a buck conector (**FIG 17 & FIG 18**).



FIG 17 - Orange and red wire - Key On Power



FIG 18 - Splice wires together

INSTALLATION INSTRUCTIONS

Installation

If the light option was selected, a breakdown of the light harness is shown below (**FIG 19**).

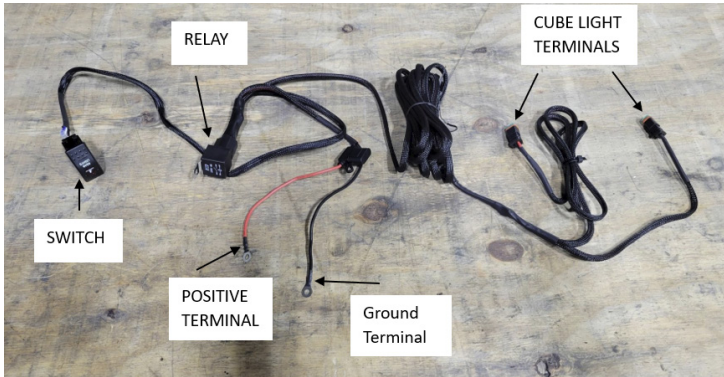

FIG 19 - Breakdown of light harness

Connect the positive and negative terminal of the harness to the busbar located under the hood (**FIG 20**).

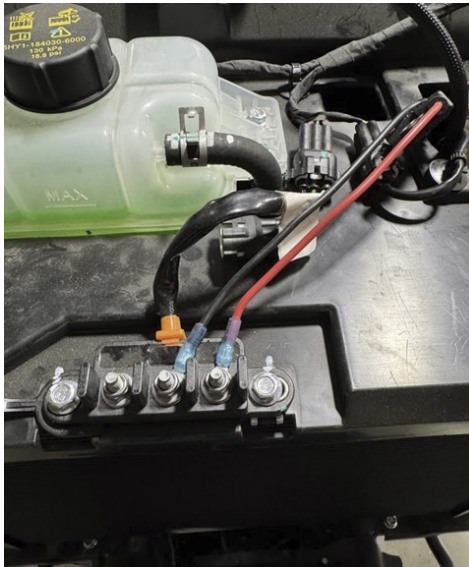

FIG 20 - Connect Harness to Busbar

INSTALLATION INSTRUCTIONS

Installation

Remove a switch cover from an open position in the dash to run the switch wire through the dash (**FIG 21**).



FIG 21 - Remove Switch Cover

Connect the harness to the switch before inserting the switch into the dash. Connect the wires to the switch with black on the top terminal, white on the middle, and blue on the bottom terminal (**FIG 22 & FIG 23**).



FIG 22 & FIG 23 - Wire switch and install into Dash

INSTALLATION INSTRUCTIONS

PRODUCT DISCLAIMER

The installation of products sold or manufactured by Thumper Fabrication, LLC (Thumper Fab) including, but not limited to suspension components such as lift kits, audio roofs, roll cages, frame stiffener kits, and tires that exceed the original specifications for the vehicle, may change the vehicle's center of gravity and handling characteristics both on- and off-road. You are aware that the installation of tires that are larger than original vehicle specifications may reduce the effectiveness of the braking system. Use of these products may place added stress to the original factory vehicle components which could cause them to weaken or possibly fail.

Products sold or manufactured by Thumper Fab are intended for off-road use only. Operation of a vehicle modified with these products on a road could result in serious bodily injury or death, and such operation may violate the laws of your state or municipality. You agree to operate your vehicle exclusively in the manner intended by the vehicle manufacturer. You agree that failure to safely and reasonably operate your vehicle could result in serious bodily injury or death, and that, as a result of installation of this product(s) to your vehicle, extreme care must be taken to prevent vehicle rollover or loss of control, which may be more likely to occur as a result of said modifications. You will avoid unsafe maneuvers, including sudden sharp turns or other abrupt maneuvers, which could make a vehicular accident more likely. You understand that Thumper Fab is not responsible or liable for any damages or any injuries to yourself or your passengers that could occur upon possible accidents due to driver error, incorrect installations, bad judgment, incompatibility with other aftermarket accessories or natural disasters to the fullest extent allowable by law. You will have all vehicle occupants fasten seatbelts, if equipped, and wear proper safety equipment, such as DOT approved helmet and eye protection prior to operating the vehicle. You understand and acknowledge that failure to wear proper safety equipment may increase the risk of serious bodily injury or death to yourself and any passengers.

Proper installation of products sold or manufactured by Thumper Fab requires knowledge of the factory recommended procedures for removal and installation of original equipment components. Installation of these products without proper knowledge and experience may affect the performance of these components and the safety of the vehicle and cause serious bodily injury or death. It is strongly recommended that a certified mechanic familiar with the installation of similar components perform the product(s) installation.

Prior to installing any products sold or manufactured by Thumper Fab, you will perform or cause to be performed an inspection of their vehicle to confirm its condition is suitable for the installation of these products. A proper inspection of the vehicle includes confirmation that the vehicle has not been in a collision and is free of corrosion. If the vehicle is suspected to have been in a collision or misused, or is otherwise unsuitable for modification, you will not install the product(s). You will continue to inspect the vehicle prior to each use to confirm its condition is suitable for its intended use, and you acknowledge that the failure to do so may result in serious bodily injury or death, as well as damage to the vehicle itself.

You will install any warning labels provided with the product so it may be prominently seen by yourself and all passengers. You will notify all passengers of the modifications performed to your vehicle prior to operation.

Insurance companies may handle coverage of a modified vehicle differently. Please check with your insurance carrier prior to modifying the vehicle to ensure your coverage remains sufficient. Installation of this product(s) may void your vehicle warranty. If this is a concern, please check with the manufacturer or dealer before purchase or installation of this product(s).



THUMPER FAB

Thumper Fab

5103 Elysian Fields Rd, Marshall, TX 75672

Customer Service: 903-472-0928

www.thumperfab.com