



THUMPER FAB

Aluminum Audio Roofs • Roll Cages • UTV Accessories

Polaris Ranger 1500XD Headache Rack

SKU: TF231601



Thumper Fab

5103 Elysian Fields Rd, Marshall, TX 75672

Customer Service: 903-472-0928

www.thumperfab.com

Ver. 0824

Polaris Ranger 1500XD Headache Rack

SKU: TF231601



PARTS

REF	QTY	DESCRIPTION
1	1	Headache Rack Frame
2	1	Headache Rack Insert Panel
3	1	Rear Cab Light Cover
4	1	Winch Stop
5	1	Fairlead
6	1	Winch
7	1	Winch Hook
8	1	Rear Cab Light Extension Harness

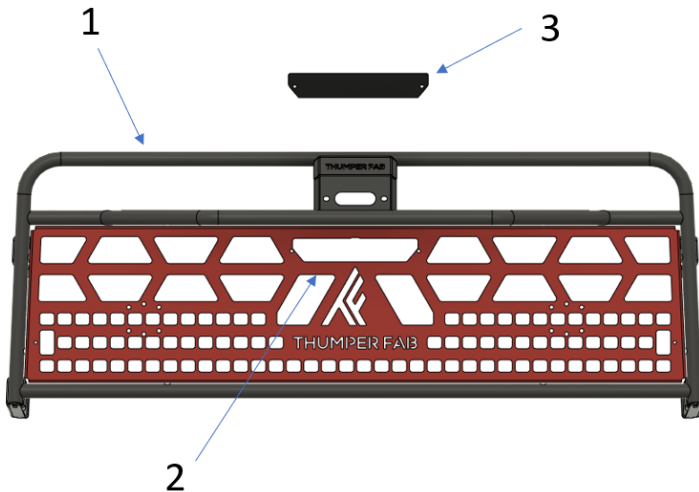

Polaris Ranger 1500XD Headache Rack

SKU: TF231601



HARDWARE

HARDWARE KIT		
A	12	M8 X 20mm Flange Head Bolt
B	3	#10 x 1/2" Pointed Screw
C	2	Zip Ties
D	4	M6 x 20mm Flange Head Bolt
E	4	M6 Lock Washer
F	2	1/4" x 3/4" Button Head Screw
G	2	1/4" Nylon Lock Nut

TOOLS

- Ratchet
- 10mm Socket
- 13mm Socket
- 13mm Wrench
- 14mm Wrench
- T25 Torx
- 5/32" Allen
- 7/16" Wrench

BEFORE YOU BEGIN

If you do not feel comfortable installing your Thumper Fab Headache Rack, please see your nearest Polaris® Dealer for installation.

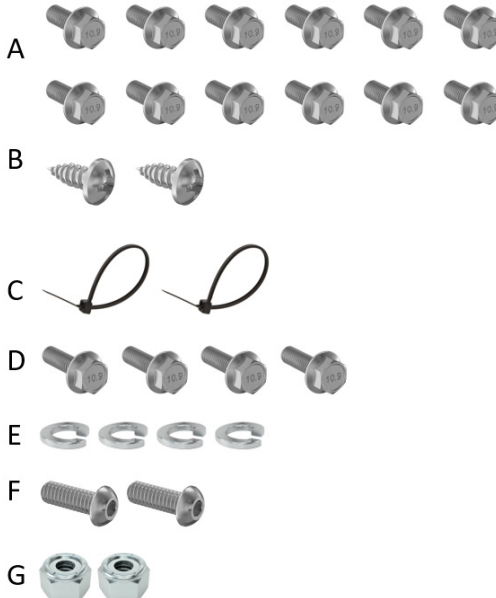

INSTALLATION INSTRUCTIONS

Installation Preparation

Start by fastening the headache rack insert panel (2) to the headache rack frame (1) using 8 x M8 x 20 flange head bolts (A) and a 13mm wrench (FIG 1).



FIG 1 - Fasten Panel (2) to Frame (1) using 13mm Wrench

Mount fairlead (5) to headache rack frame (1) using hardware provided in winch box. Tighten using 13mm socket and 14mm wrench (FIG 2).



FIG 2 - Fasten Fairlead (5) to Frame (1) using 13mm Socket and 14mm Wrench

INSTALLATION INSTRUCTIONS

Installation Preparation

Mount the winch (6) to the frame (1) using 4 x M6 lock washers (E) and 4 x M6 x 20mm flange head bolts (D). Tighten using 10mm socket (FIG 3).



FIG 3 - Fasten Winch (6) to Frame (1) using 10mm Socket

Route the cable from the winch (6) through the fairlead (5) and install the winch stop (4) using a 10mm socket (FIG 4).



FIG 4 - Fasten Winch Stop (4) to Cable of Winch (6) using a 10mm Socket

INSTALLATION INSTRUCTIONS

Installation Preparation

Mount the winch hook (7) to the cable of the winch (6) using a cotter pin (FIG 5).

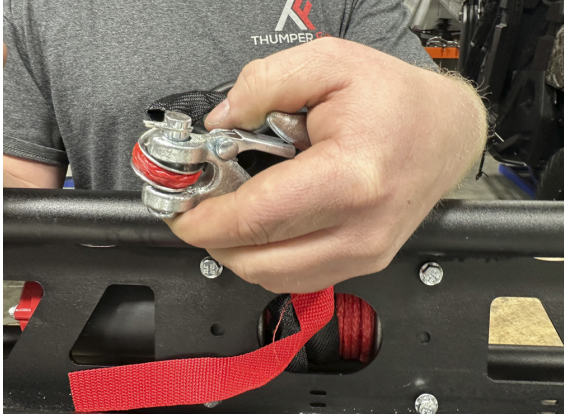

FIG 5 - Fasten Winch Hook (7) to cable of Winch (6) using cotter pin

Use a T25 Torx bit to remove the OEM bed light (FIG 6). Plug in the extension harness (8) for the rear light and route down in between the rear window and roof (FIG 7).

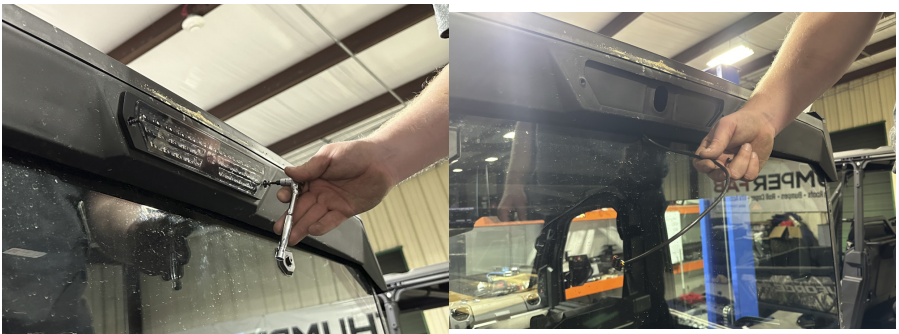

FIG 6 & FIG 7 - Remove OEM bed light using T25 Torx. Plug in Extension Harness (8) and route in between rear window and roof.

INSTALLATION INSTRUCTIONS

Installation Preparation

Mount the rear cab light to the headache rack insert panel (2) using 2 x 1/4" x 3/4" button head screws and 2 x 1/4" nylon lock nuts. Tighten using 5/32 allen and 7/16" wrench (FIG 8).



FIG 8 - Fasten Rear Cab Light to Insert Panel (2) using a 5/32" Allen and 7/16" Wrench

Start the remaining 4 x M8 x 20mm flange head bolts (A) into the 4 holes in the back of the roll cage. Once all slightly started, place headache rack over bolts and tighten evenly using a 13mm wrench (FIG 9 & FIG 10).

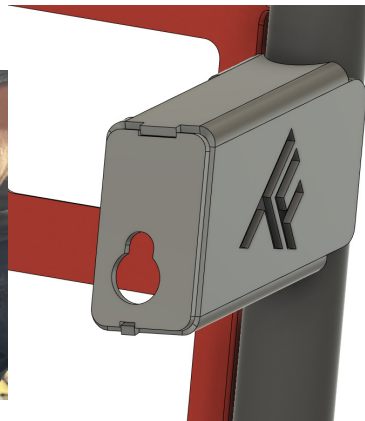

FIG 9 & FIG 10 - Place rack over pre-started bolts using slot shown in FIG 10. Tighten evenly using 13mm Wrench

INSTALLATION INSTRUCTIONS

Winch Wiring

Do not refer to wiring instructions contained in the winch box as it is not suitable for this application. Reference the following wiring diagram for wiring instructions for the winch (**FIG 11**).

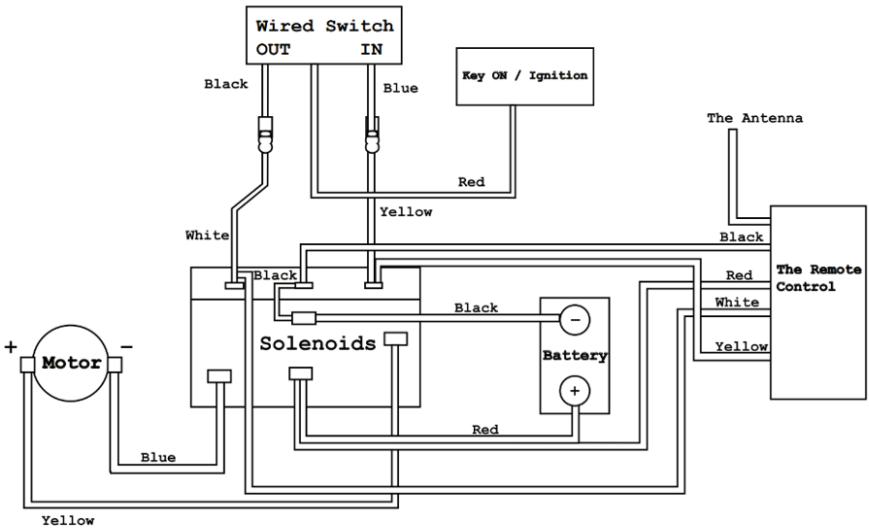

FIG 11 - Winch Wiring Diagram

INSTALLATION INSTRUCTIONS

Install Cube Lights (Optional)

Attach cube lights to the mount brackets using the hardware and brackets provided in the cube light box (FIG 12 & FIG 13).



FIG 12 & FIG 13 - Fasten Cube Light to Mount Bracket

Using the hardware provided in the cube light box, fasten the cube light to the headache rack. Use the provided holes in the winch mount plate to zip tie the cube light wires to the headache rack (FIG 14 & FIG 15).



FIG 14 - Fasten Cube Light to Headache Rack



FIG 15 - Zip Tie Cube Light wire pigtail to Headache Rack

INSTALLATION INSTRUCTIONS

Wiring Harness

A wiring harness and switch are provided to power your cube lights (FIG 16).

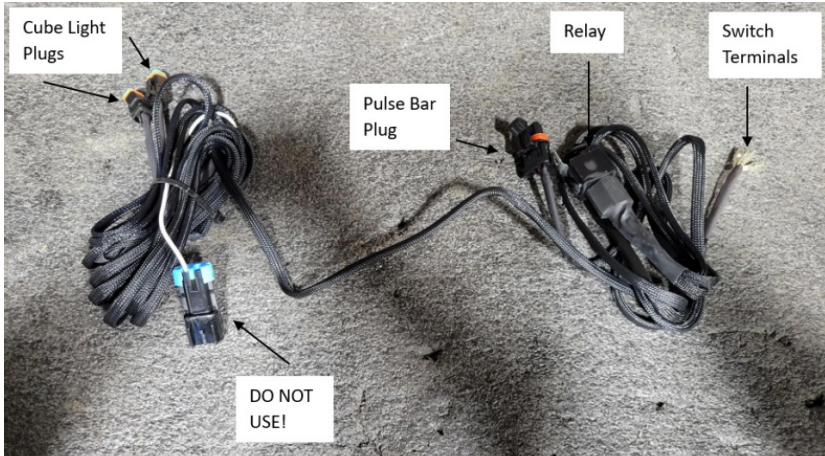

FIG 16 - Break down of Wiring Harness plugs and terminals

Under the hood, locate an unused spot on your pulse bar and remove cover plug to allow for Thumper Fab harness to be plugged into pulse bar (FIG 17 & FIG 18).



FIG 17 - Remove unused Pulse Bar Plug



FIG 18 - Plug in Thumper Fab pulse bar pigtail

INSTALLATION INSTRUCTIONS

Feed cube light pigtails down through hole shown below and route the wires to the back of the unit (**FIG 19**).

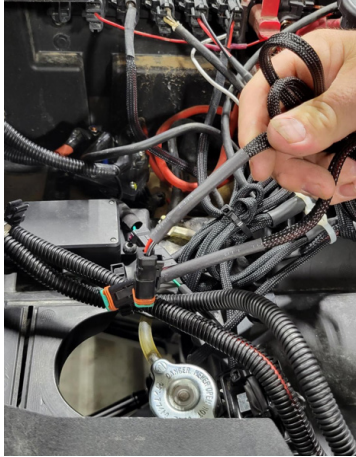

FIG 19 - Route Cube Light plugs from under hood to the rear of the vehicle

Feed the 3 switch terminal wires through the grommet in the firewall to prepare for connection to the switch (**FIG 20**).



FIG 20 - Feed switch terminals through grommet in firewall

INSTALLATION INSTRUCTIONS

Route the switch wires under the dash through your selected switch port and hook terminals to the switch with blue on top, white in middle, and black on bottom (**FIG 21**).

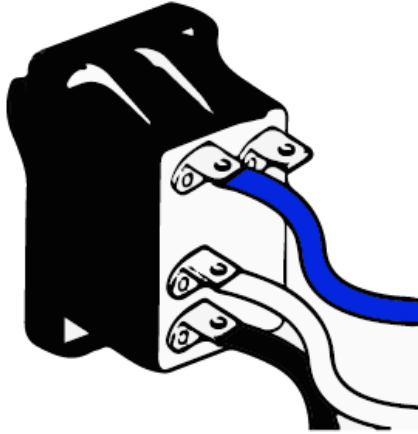

FIG 21 - Slide wires onto switch terminals

Snap switch into dash (**FIG 22**).



FIG 22 - Snap switch into place in dash

INSTALLATION INSTRUCTIONS

PRODUCT DISCLAIMER

The installation of products sold or manufactured by Thumper Fabrication, LLC (Thumper Fab) including, but not limited to suspension components such as lift kits, audio roofs, roll cages, frame stiffener kits, and tires that exceed the original specifications for the vehicle, may change the vehicle's center of gravity and handling characteristics both on- and off-road. You are aware that the installation of tires that are larger than original vehicle specifications may reduce the effectiveness of the braking system. Use of these products may place added stress to the original factory vehicle components which could cause them to weaken or possibly fail.

Products sold or manufactured by Thumper Fab are intended for off-road use only. Operation of a vehicle modified with these products on a road could result in serious bodily injury or death, and such operation may violate the laws of your state or municipality. You agree to operate your vehicle exclusively in the manner intended by the vehicle manufacturer. You agree that failure to safely and reasonably operate your vehicle could result in serious bodily injury or death, and that, as a result of installation of this product(s) to your vehicle, extreme care must be taken to prevent vehicle rollover or loss of control, which may be more likely to occur as a result of said modifications. You will avoid unsafe maneuvers, including sudden sharp turns or other abrupt maneuvers, which could make a vehicular accident more likely. You understand that Thumper Fab is not responsible or liable for any damages or any injuries to yourself or your passengers that could occur upon possible accidents due to driver error, incorrect installations, bad judgment, incompatibility with other aftermarket accessories or natural disasters to the fullest extent allowable by law. You will have all vehicle occupants fasten seatbelts, if equipped, and wear proper safety equipment, such as DOT approved helmet and eye protection prior to operating the vehicle. You understand and acknowledge that failure to wear proper safety equipment may increase the risk of serious bodily injury or death to yourself and any passengers.

Proper installation of products sold or manufactured by Thumper Fab requires knowledge of the factory recommended procedures for removal and installation of original equipment components. Installation of these products without proper knowledge and experience may affect the performance of these components and the safety of the vehicle and cause serious bodily injury or death. It is strongly recommended that a certified mechanic familiar with the installation of similar components perform the product(s) installation.

Prior to installing any products sold or manufactured by Thumper Fab, you will perform or cause to be performed an inspection of their vehicle to confirm its condition is suitable for the installation of these products. A proper inspection of the vehicle includes confirmation that the vehicle has not been in a collision and is free of corrosion. If the vehicle is suspected to have been in a collision or misused, or is otherwise unsuitable for modification, you will not install the product(s). You will continue to inspect the vehicle prior to each use to confirm its condition is suitable for its intended use, and you acknowledge that the failure to do so may result in serious bodily injury or death, as well as damage to the vehicle itself.

You will install any warning labels provided with the product so it may be prominently seen by yourself and all passengers. You will notify all passengers of the modifications performed to your vehicle prior to operation.

Insurance companies may handle coverage of a modified vehicle differently. Please check with your insurance carrier prior to modifying the vehicle to ensure your coverage remains sufficient. Installation of this product(s) may void your vehicle warranty. If this is a concern, please check with the manufacturer or dealer before purchase or installation of this product(s).



THUMPER FAB

Thumper Fab

5103 Elysian Fields Rd, Marshall, TX 75672

Customer Service: 903-472-0928

www.thumperfab.com